

## WIRING DIAGRAM

### Front panel

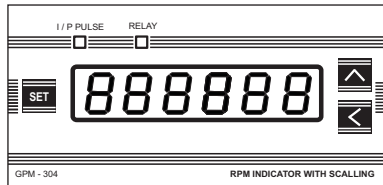

### ■ Dimensions

#### ● External dimensions

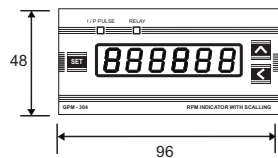

#### ● Panel cutout dimensions

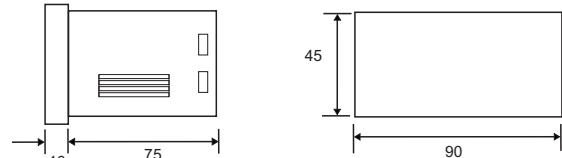

All dimensions are in mm

### Rear panel - Connection diagram

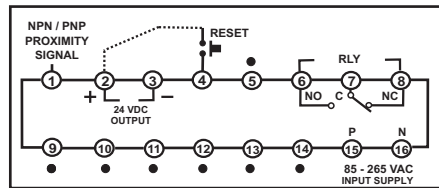

## SPECIFICATIONS

Range	999 999 RPM
Display	Six digits, 0.4 Inch seven segment LED
Reset : Auto / Manual	Auto reset Time 000.1 Sec to 999.9 Sec
Input	NPN (or) PNP Proximity unit (Selectable)
Indications	Input Pulse and Relay ON
Set points	Two
Output	One relay, 1 c/o
Relay contact rating (Resistive load)	10 A @ 230 VAC / 30 VDC
Mechanical life of relay	10 million operation
Electrical life of relay	100.000 operation
User programming	3 Keys & Display
Power consumption	4.8 VA
Supply voltage	85 - 265 VAC , 50 Hz
Operating voltage range	+ / -10% from the rated voltage
Weight	170 grams
Dimension (L x W x D)	96 x 48 x 75
Ambient humidity	35 to 85 % RH
Ambient temperature	-10 to 55 °C
Storage temperature	-25 to 65 °C
In the pack	RPM Indicator, clamp and instruction manual

## GPM - 304

RPM INDICATOR WITH SCALLING

## INSTRUCTION MANUAL

**GREEN™**  
COMPONENTS FOR AUTOMATION

### Introduction

Thank you very much for purchasing this GREEN product GPM - 304. Please read the instruction manual carefully for the full usage of this product

The unit has passed various quality tests before despatch. Please check however, at the time of arrival, its model code and its appearance and ensure that all the contents are provided and there are no faults, damage etc, to the timer. Please also ensure that the model code, which is labeled on the unit, is identical to the one you ordered.

### Note

- Our company shall not be liable for any damages, as described below, caused to both any users and third parties
  - Damages caused by the result of operation of the product.
  - Damages caused by any defects in the product which are unpredictable for us.
- The content in this manual are subject to change without any notice. If you have any suggestion on the matter, Please do not hesitate to contact us.

### Precaution for safe use

- Use and store the product within the specified ambient temperature and humidity ranges.
- Do not use the product in location subject to vibrations or shocks. Using the product in such location over a long period may result in damage due to stress.
- Do not use the product in locations subject to dust, corrosive gases, or direct sunlight
- Separate the input signal devices, input signal cables and the product from the source of noise or high - tension cables producing noise
- The supplied power voltage and load must be within the rated and specified ranges.
- Do not use where the water or oil splatter on the Timer
- Install a switch or circuit breaker that allows the operator to immediately turn off the power

### Wiring Diagram

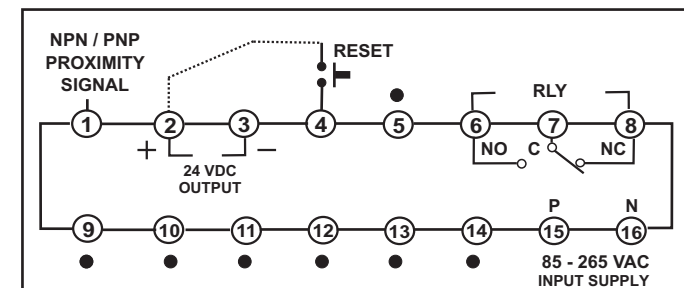

### Manufacturer

**GREEN MICROELECTRONICS INDIA PVT. LTD.**

100 Taskant street, B.R. Puram, Peelamedu,  
Coimbatore - 641004. Phone no : 0422 4218101

e- mail : greenmicroelectronics@airtelmail.in - www.greenelectronics.in

# Operation procedure :

## Initial Setting

Press **SET** before Power ON

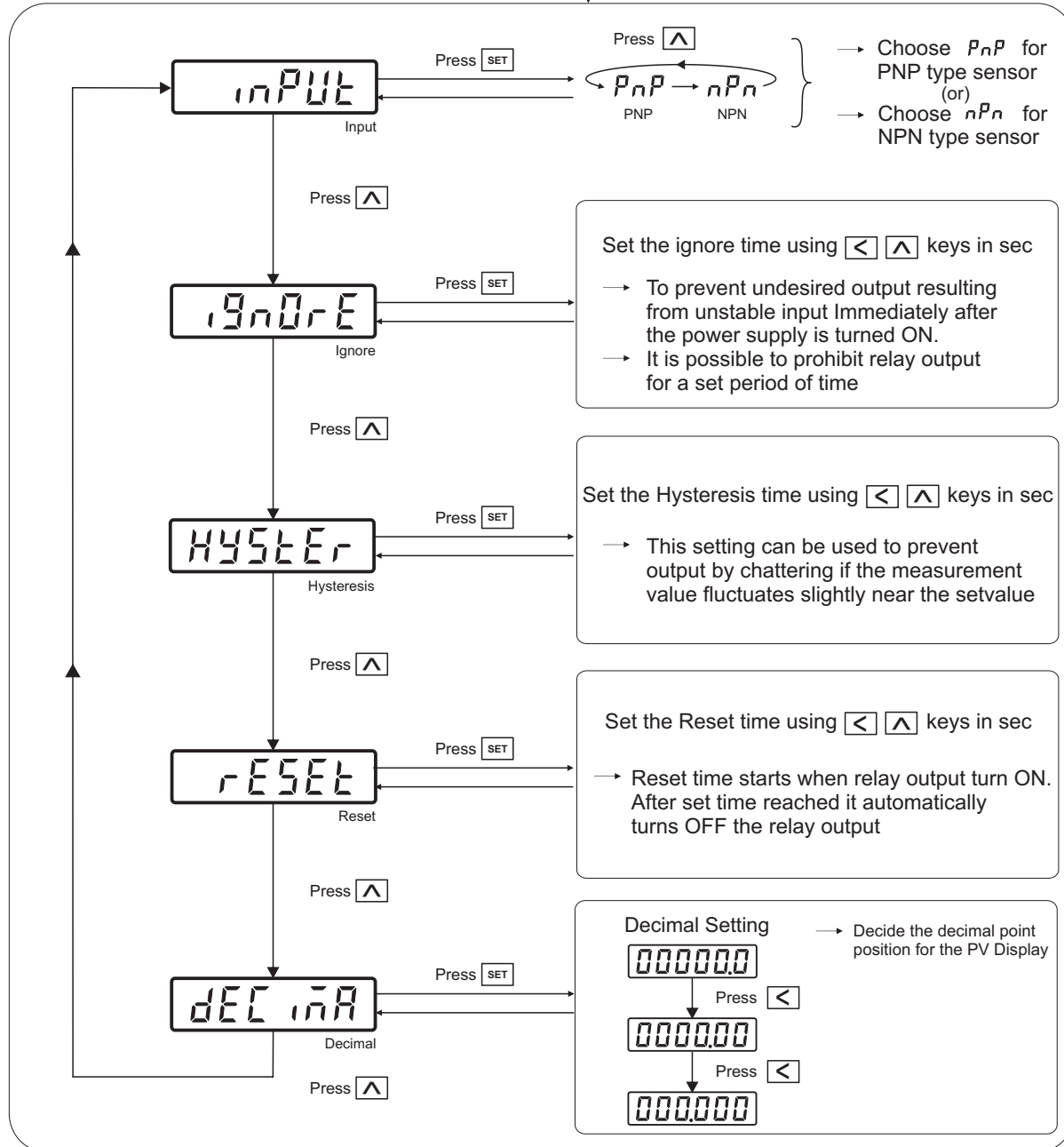

Power ON

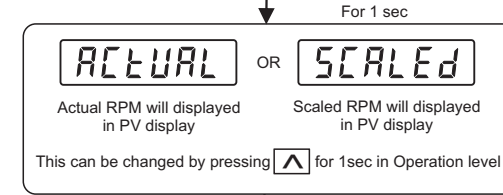

## Operation level

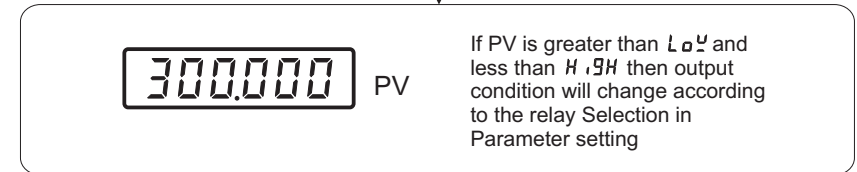

## Parameter setting

